

# Basic Polarization Techniques and Devices

© 2005 Meadowlark Optics, Inc

*This application note briefly describes polarized light, retardation and a few of the tools used to manipulate the polarization state of light. Also included are descriptions of basic component combinations that provide common light manipulation tools such as optical isolators, light attenuators, polarization rotators and variable beam splitters.*

## Light Polarization

In classical physics, light of a single color is described by an electromagnetic field in which electric and magnetic fields oscillate at a frequency, ( $\nu$ ), that is related to the wavelength, ( $\lambda$ ), as shown in the equation

$$c = \lambda\nu$$

where  $c$  is the velocity of light. Visible light, for example, has wavelengths from 400-750 nm.

An important property of optical waves is their polarization state. A vertically polarized wave is one for which the electric field lies only along the z-axis if the wave propagates along the y-axis (Figure 1A). Similarly, a horizontally polarized wave is one in which the electric field lies only along the x-axis. Any polarization state propagating along the y-axis can be superposed into vertically and horizontally polarized waves with a specific relative phase. The amplitude of the two components is determined by projections of the polarization direction along the vertical or horizontal axes. For instance, light polarized at  $45^\circ$  to the x-z plane is equal in amplitude and phase for both vertically and horizontally polarized light (Figure 1B).

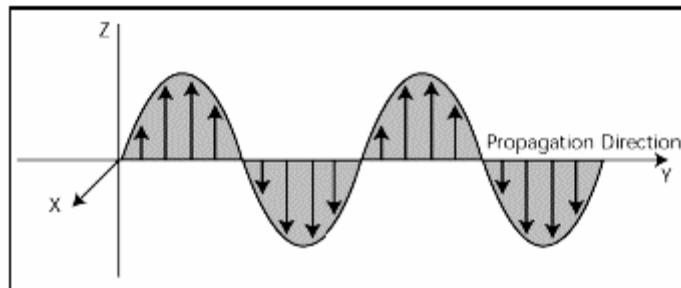

A. Linearly Polarized Light in the Vertical Direction

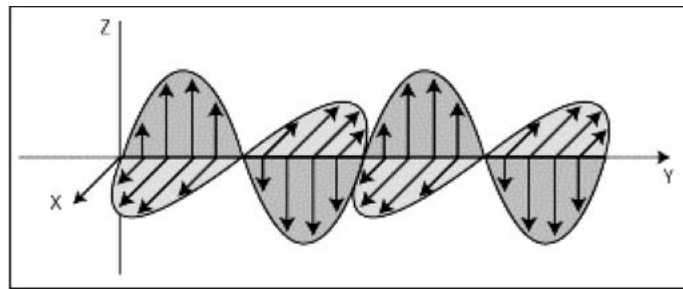

B. Linearly Polarized Light at 45 Degrees

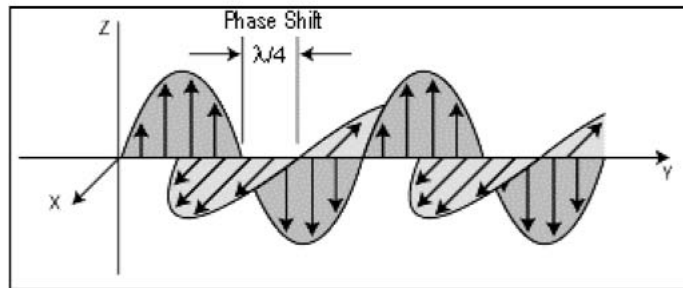

C. Circularly Polarized Light

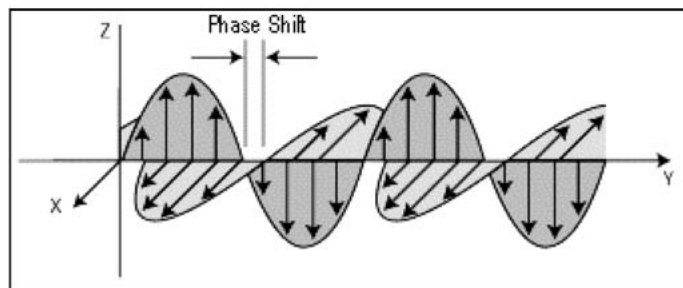

D. Elliptically Polarized Light

Fig. 1: Various polarizations of light

Circularly polarized light is created when one linear electric field component is phase shifted in relation to the orthogonal component by  $\lambda/4$ , as shown in Figure 1C.

Elliptically polarized light represents an arbitrary phase shift between the two electric field components, as seen in Figure 1D.

We produce linearly polarized light when we send unpolarized light through a polarizing medium whose axis is in line with the desired linear polarization. Passing this polarized light through a second polarizer allows only the components that are parallel to the polarizing axis to emerge while the orthogonal component is absorbed. If vertically polarized light is sent through a polarizer oriented at  $45^\circ$  the emerging light is reduced in amplitude by a factor of  $1/\sqrt{2}$  and in intensity by 50% of the original intensity. If vertically polarized light is sent through a horizontally oriented polarizer no component of the original light is parallel to the polarization direction and no light emerges.

## Retardation

Another useful tool for manipulating polarized light is the phase retarder. Phase retardation is accomplished by making the optical path length for one of the orthogonal polarizations different than the other.

### Quarter Wave Retarder

If the orthogonal electric field components are equivalent, a phase shift in one component will result in circularly polarized light, as shown in part C of Figure 1. Retarders that cause this shift are known as quarter wave retarders. They have the unique property of turning elliptically polarized light into linearly polarized light or of transforming linearly polarized light into circularly polarized light when the fast axis of the quarter wave plate is at  $45^\circ$  to the incoming polarization plane. This is done using birefringent, uniaxial materials having two different refraction indices. Light polarized along the direction with the smaller index travels faster and thus this axis is termed the fast axis. The other axis is the slow axis.

Alignment of quarter wave retarders is accomplished with the use of a linear polarizer and a mirror as demonstrated in Figure 2. Using a Polarizing Beam Splitter, vertically polarized light is passed through a quarter wave plate and onto a mirror. When the angle between the fast axis of the quarter wave plate and the polarization plane is at  $45^\circ$ , the reflected light has a polarization that is  $90^\circ$  to the polarization of the original source. This maximizes the light at B and minimizes the light at reference point A, as shown in Figure 2.

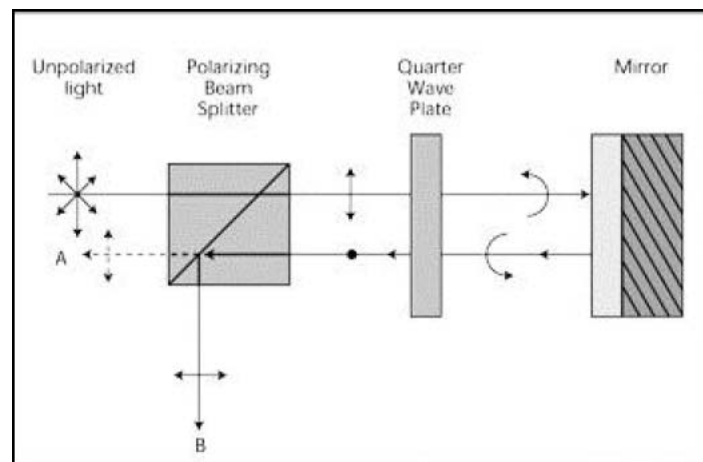

Fig. 2. A quarter wave alignment technique

### Half Wave Retarder

A retarder that produces a  $\lambda/2$  phase shift is known as a half wave retarder. Half wave retarders can rotate the polarization of linearly polarized light to twice the angle between the retarder fast axis and the plane of polarization. Placing the fast axis of a half wave retarder at  $45^\circ$  to the polarization plane results in a polarization rotation of  $90^\circ$ .

Passing circularly polarized light through a half wave plate changes the "handedness" of the polarization. This is the same as shifting the horizontal polarization in Figure C by one  $\lambda$ .

## Optical Isolators

Retarders used in conjunction with polarizers provide many useful devices. For example, optical isolation can be achieved by combining a linear polarizer with a quarter wave retarder. Properly aligning the quarter wave retarder with the linear polarizer turns linearly polarized light into circularly polarized light. Because circularly polarized light exhibits a shift in handedness upon specular reflection, the reflected light is now linearly polarized and rotated  $90^\circ$  from the light leaving the isolator. Horizontally polarized light falling on a vertically aligned polarizer is rejected.

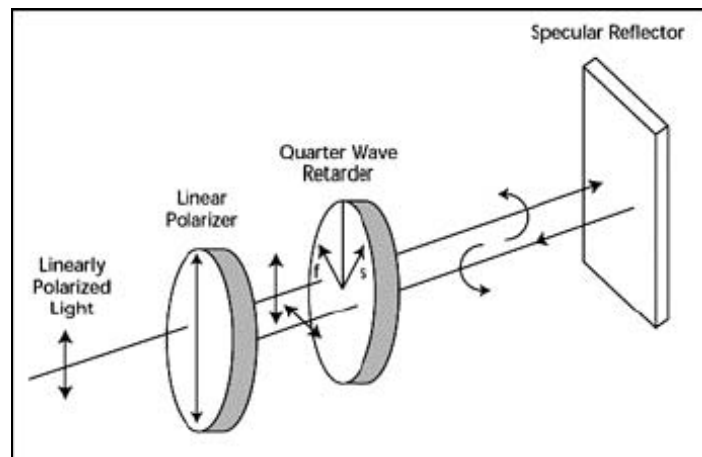

Fig. 3. Demonstration of optical isolation

## Optical Attenuators

An optical attenuator is built by combining two linear polarizers and a half wave plate. The input and output polarizers are crossed so that no light passes through them, however, inserting the half wave plate allows light to pass through the device. The amount of light is determined by the angle between the optical axis of the incoming polarizer and half wave plate. Placing the half wave plate's optical axis at  $45^\circ$  to the incoming polarizer achieves a maximum transmission; aligning the optical axis of the half wave plate with either of the input or output polarizers optical axes gives the minimum transmission. How close the minimum is to zero transmission depends on the quality of the polarizers and half wave plate used in the device.

Replacing the half wave plate with a device that varies the polarization, such as a variable retarder, creates a variable attenuator. This configuration is shown in Figure 4. When we align the fast axis of the variable retarder at  $45^\circ$  to the input polarizer and modulate the retardance between half wave and full wave, transmission varies between maximum and minimum creating an optical shutter chopper.

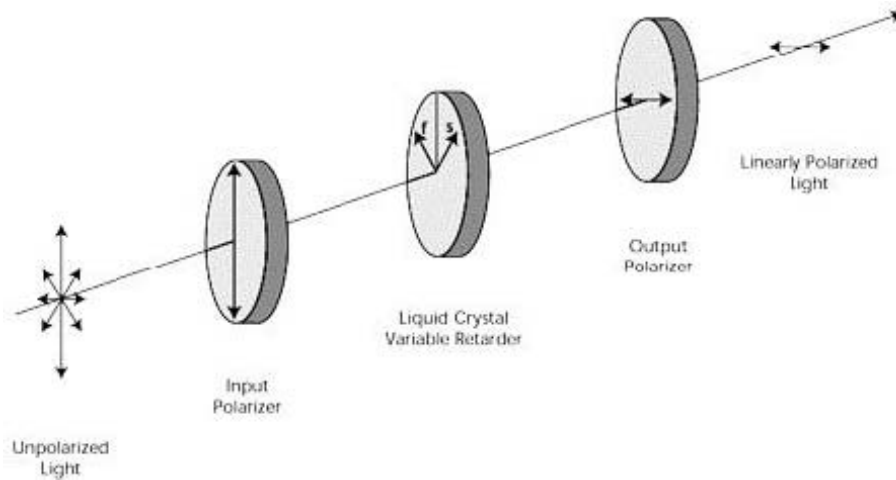
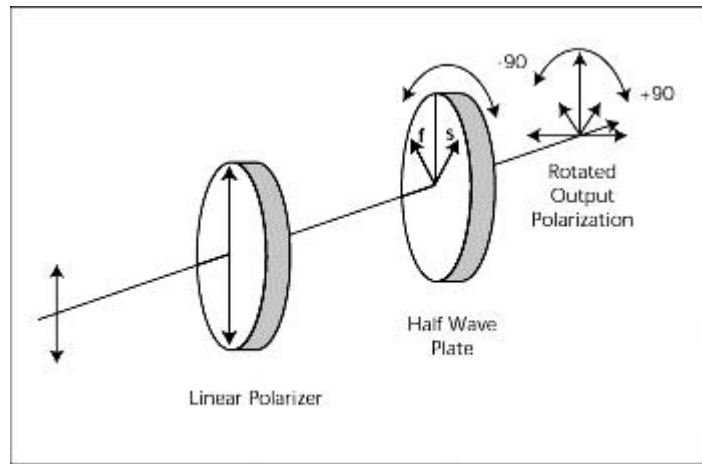

Fig. 4. The Variable Attenuator Configuration

### Polarization rotator

A simple polarization rotator consists of a half wave plate in linear polarized light. Rotating the half wave plate causes the polarization to rotate to twice the angle of the half wave plate's fast axis with the polarization plane, as shown in Figure 5A. We achieve variable polarization rotation by aligning the fast axis of a variable retarder at  $45^\circ$  to the incoming polarization and following this component with a quarter wave retarder with it's slow axis aligned with the incoming polarization as seen in Figure 5B. The amount of rotation achieved depends on the amount of retardance exhibited by the first retarder. The polarization axis is rotated to an angle that is one-half the phase shift provided by the variable retarder.



A. Polarization rotation with a half wave plate

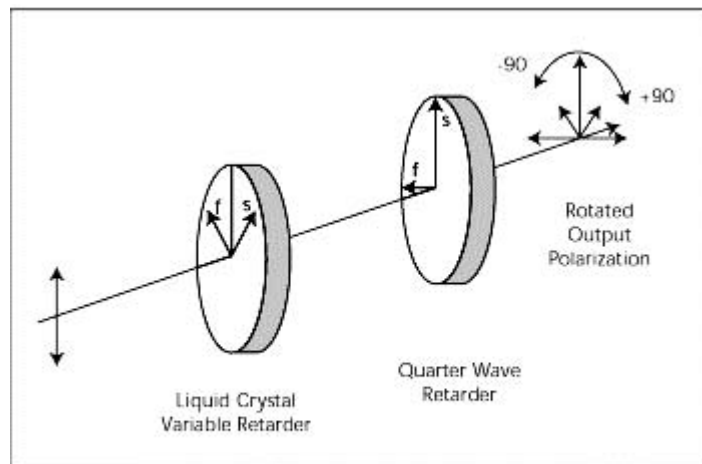

B. Variable polarization rotation with a variable retarder

Fig. 5. A demonstration of polarization rotation

### Variable Beam Splitter

We can create a variable beam splitter by putting linearly polarized light through a half wave plate in combination with a polarizing beam splitter. The polarization of the light through the beam splitter governs the amount of light the beam splitter transmits and reflects. Aligning the retarder axis with the input vertical polarization achieves total reflection by the beam cube.

Conversely, rotating the half wave plate's fast axis to a  $45^\circ$  angle with the input polarization plane provides total transmission through the beam splitter. Replacing the half wave plate with a variable retarder whose fast axis is at  $45^\circ$  to the incoming polarization gives us the same beam

splitting results as before with no mechanical motion. Varying the retardance between the 0 and half wave values creates an optical switch.

## **Conclusion**

In this application note we have given a basic description of light polarization and some of the tools used to control the polarization state of light. Retarders and polarizers were used in simple devices that provide some of the common manipulations required wherever light is being measured.